

AMIAS



Effective heatsink

has thermally optimised design which supports natural flow of the air.

Easily customisable height

is provided by practical automatic grippers which allow for adjustments with respect to the needs and requirements of the space, displayed goods and/or customer.

Quick and effortless Installation

is ensured by push-in connectors and integrated strain-relief, which is placed in the closing cover of the driver. The luminaires are also available for through-wiring.

Excellent color rendering CRI 90+

is achieved by use of Tridonic LED engines.

Thermally protected driver

reacts to overheating first by regulating its output and if the overheating lasts, it turns off automatically, so that there is no damage caused to the driver.

Color stability

is provided by a chip with **3 SDCM**, which means there is no chance to spot any possible change in quality of the light colour with the human eye.

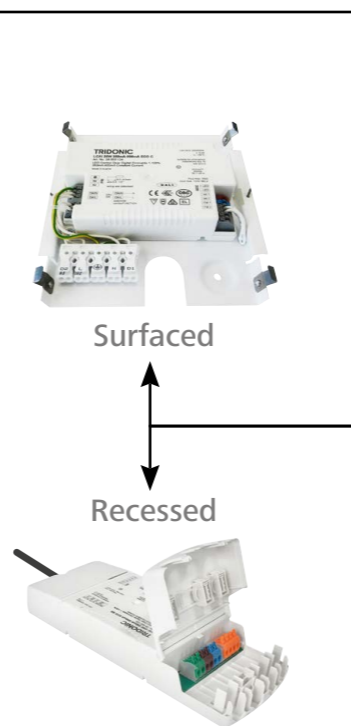

	Ra	R1	R2	R3	R4	R5	R6	R7	R8	R9	R10	R11	R12	R13	R14	R15
Tridonic 3000 K	90	90	95	99	91	90	95	90	75	42	89	93	82	91	100	84
Tridonic 4000 K	91	91	95	97	92	91	92	92	80	50	87	93	75	92	98	87

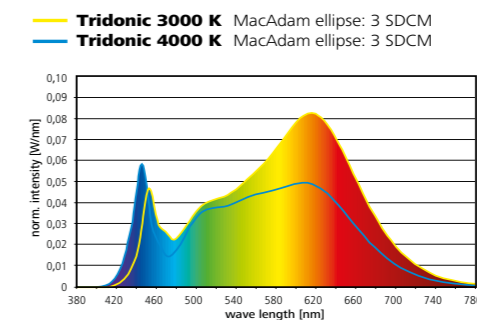
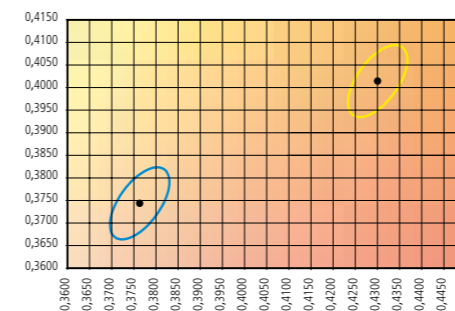

RETAIL,GASTRO & HOTEL

AMIAS
3050 lm 3000 K

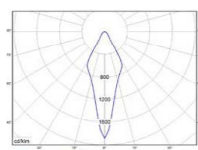

DIMENSIONS

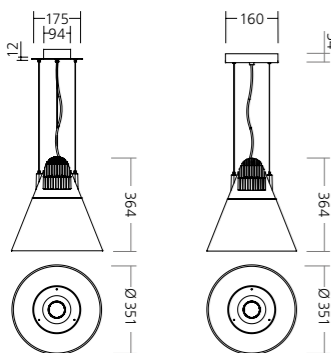

MOUNTING

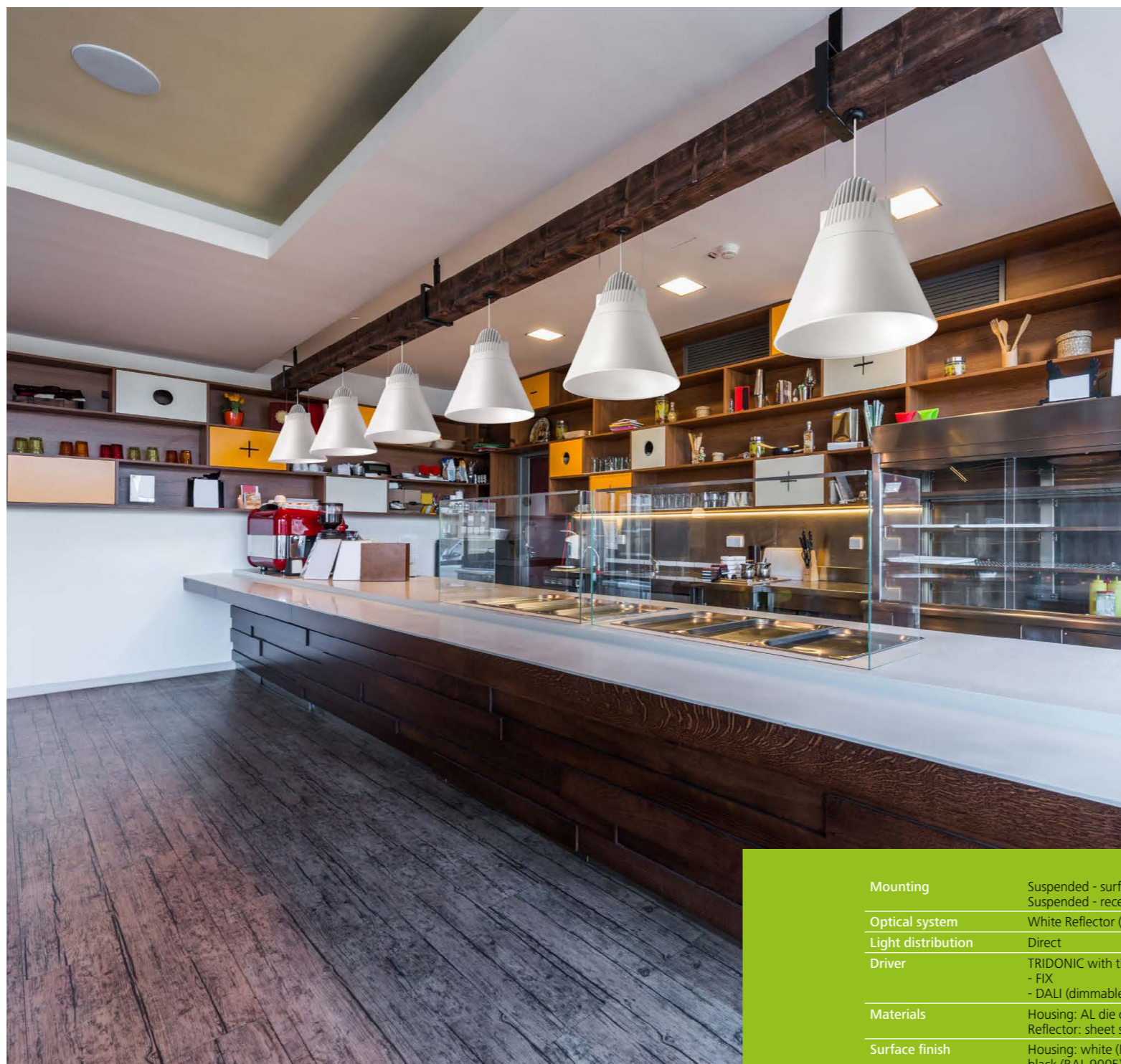
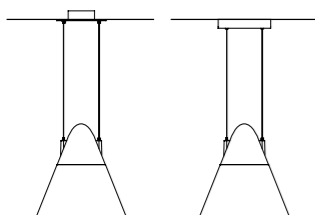

5 years warranty

LED

up to 3250 lm

up to 78 lm/W

90 Ra

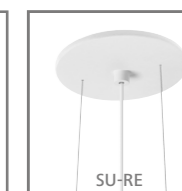

Mounting	Suspended - surfaced mounted (SU-SM) Suspended - recessed (SU-RE)
Optical system	White Reflector (WR)
Light distribution	Direct
Driver	TRIDONIC with thermal protection - FIX - DALI (dimmable 1-100%)
Materials	Housing: AL die cast Reflector: sheet steel
Surface finish	Housing: white (RAL 9003), grey (RAL 9006), black (RAL 9005)
Weight	
Service lifetime	50 000 hours, L80 / B10
Ambient temperature	0 °C / + 35 °C
EEC	A++ / A+ / A

AMIAS

Fine shape of suspended Amias luminaire will add an extra touch of stylish atmosphere to any interior design. Not only is it a fashionable decoration, it also offers both powerful illumination for large areas and spotlight on the most important items if necessary.

Type	mounting type	modul	net lumen output (at Ta = 25 °C)	power consumption	color rendering index	correlated color temperature	optic	control	color
			(lm)	(W)	CRI (Ra)	CCT (K)			
AMIAS	SU-SM / SU-RE	TRIDONIC	1950	29	90	3000	WR 27°	FIX / DALI	WHITE / GREY / BLACK
AMIAS	SU-SM / SU-RE	TRIDONIC	2050	26	90	4000	WR 27°	FIX / DALI	WHITE / GREY / BLACK
AMIAS	SU-SM / SU-RE	TRIDONIC	3200	52	90	3000	WR 27°	FIX / DALI	WHITE / GREY / BLACK
AMIAS	SU-SM / SU-RE	TRIDONIC	3250	47	90	4000	WR 27°	FIX / DALI	WHITE / GREY / BLACK

Luminous flux tolerance +/- 10%. The Company reserves the right to change any product specifications without prior notification.

STANDARD



order description: AMIAS SU-SM T 3250 940 WR27 DA WH